

M/V ERLE HOLD CAPACITIES & DIMENSIONES

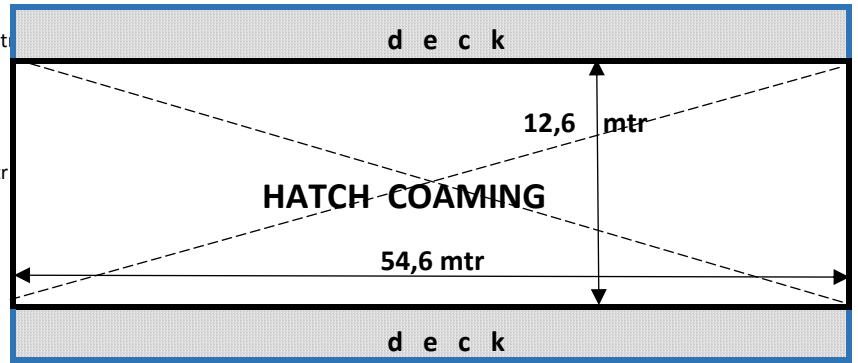

LONGUTITUNAL BULKHEAD POSITIONS

BULKHEAD POSITION 1

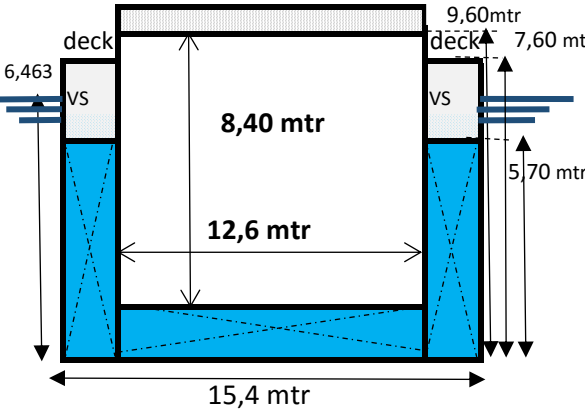
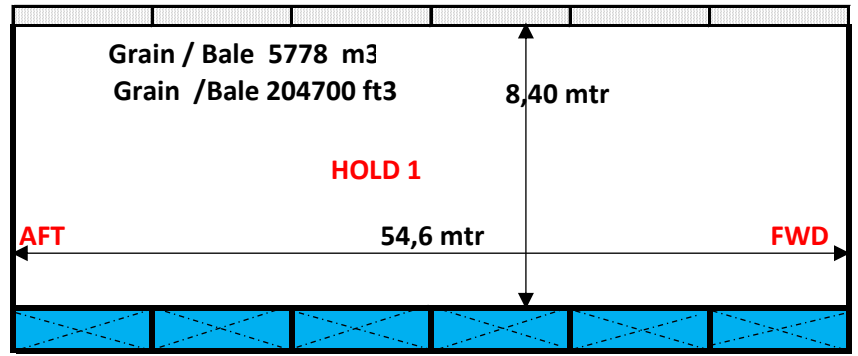
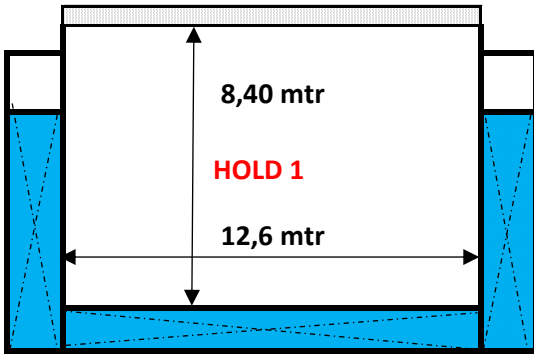
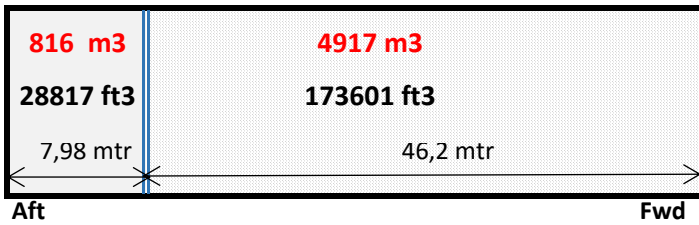

BULKHEAD POSITION 2

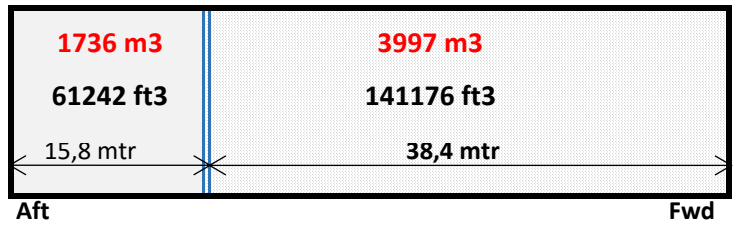

BULKHEAD POSITION 3

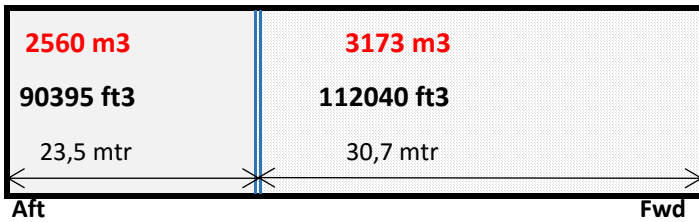

BULKHEAD POSITION 4

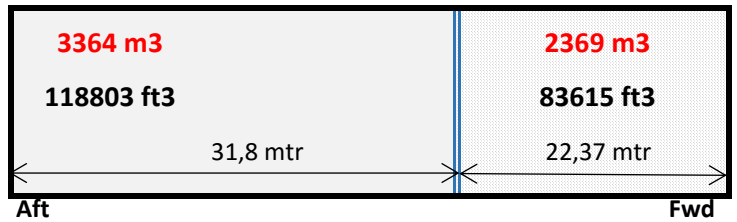

BULKHEAD POSITION 5

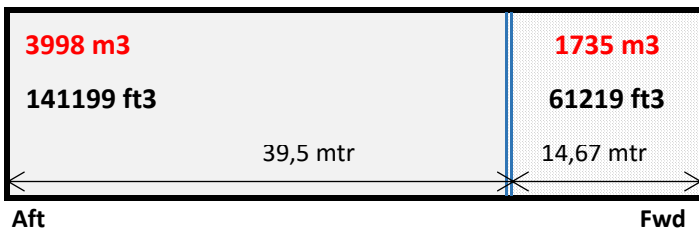

BULKHEAD POSITION 6

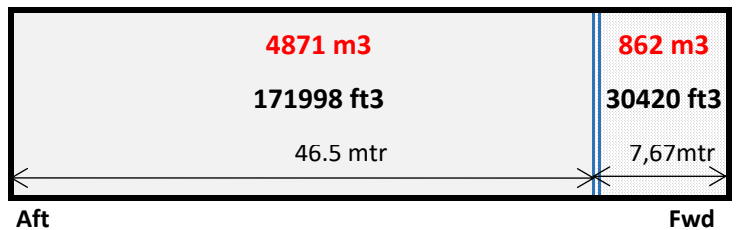

HATCH COVER

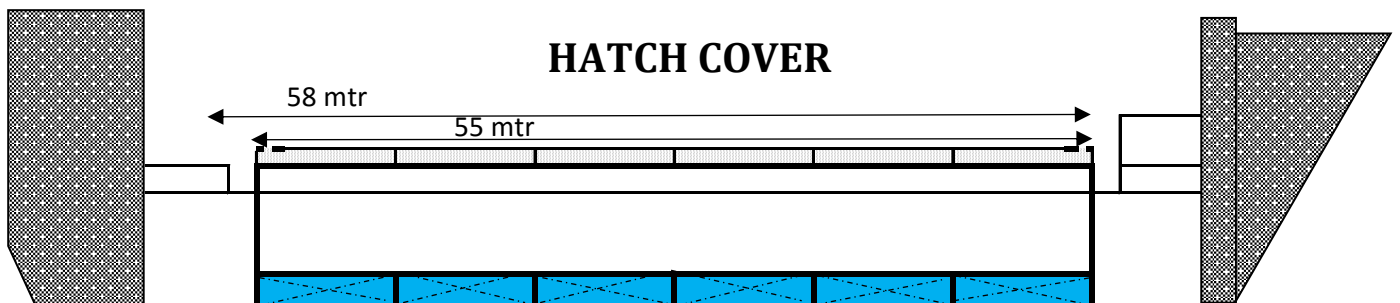

TWEENDECK POSITION 1

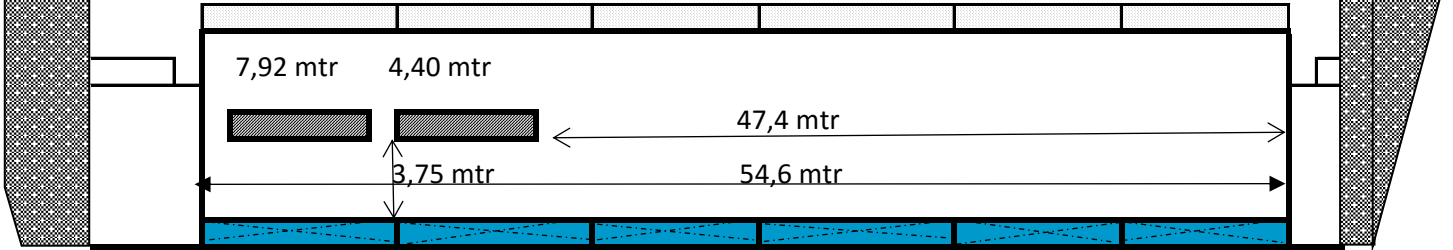

TWEENDECK POSITION 2

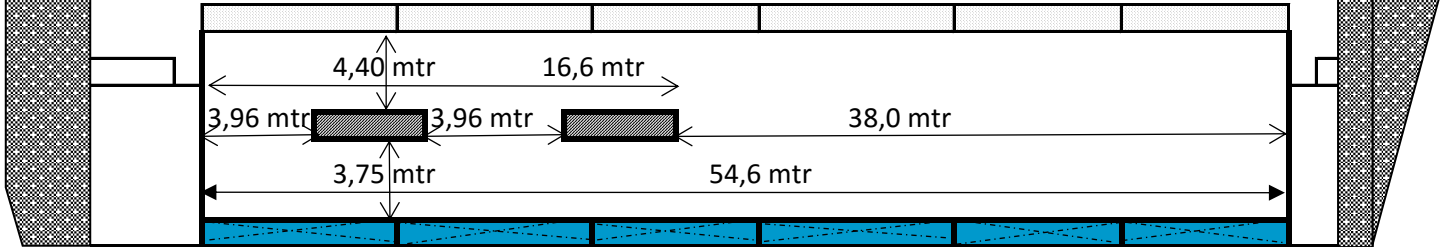

TWEENDECK POSITION 3

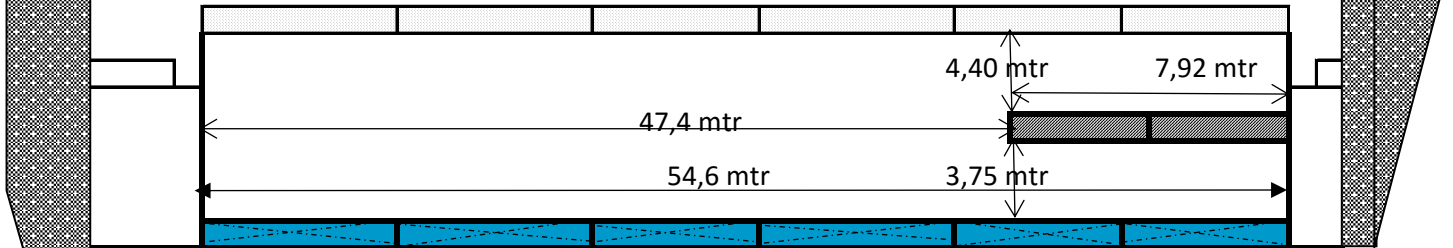

TWEENDECK POSITION 4

