

# M/V ERGE HOLD CAPACITIES & DIMENSIONES

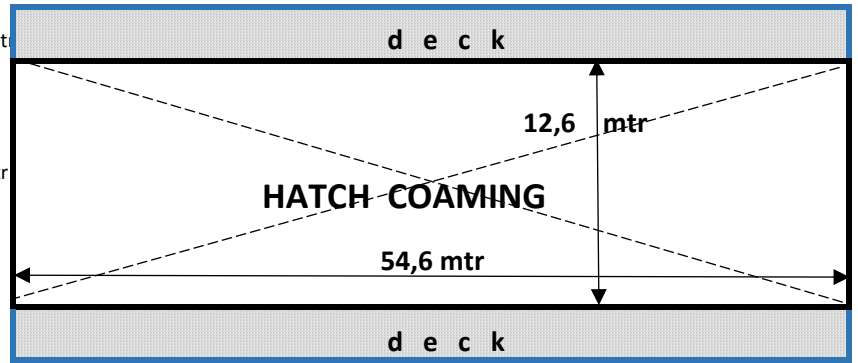

## LONGUTITUNAL BULKHEAD POSITIONS

BULKHEAD POSITION 1

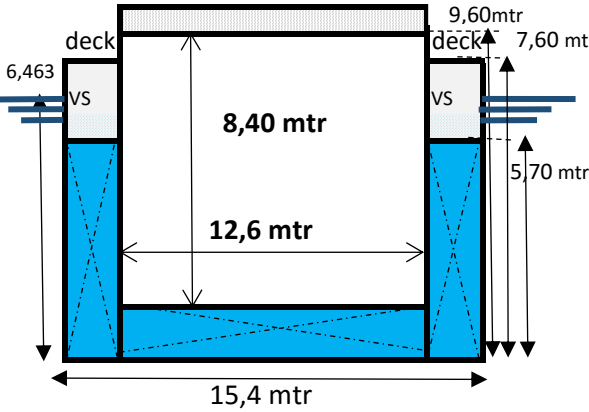
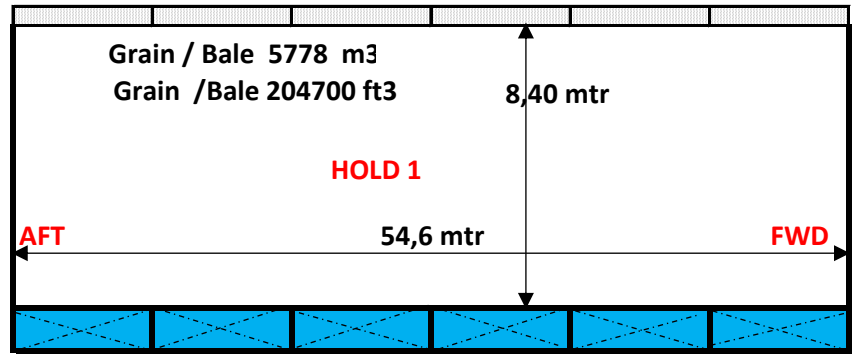
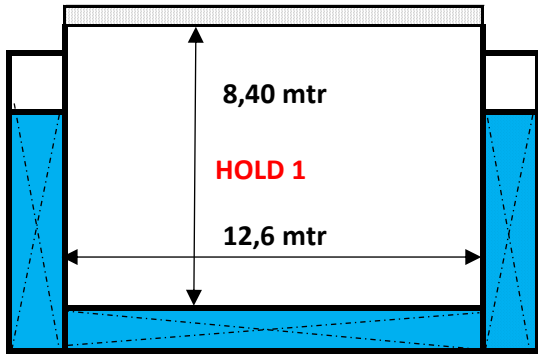
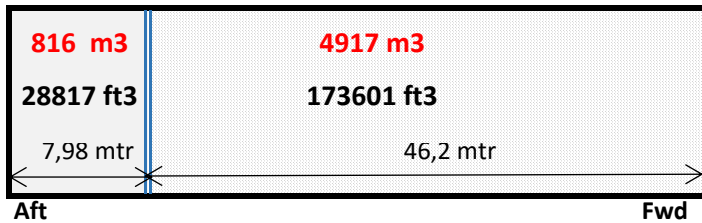

BULKHEAD POSITION 2

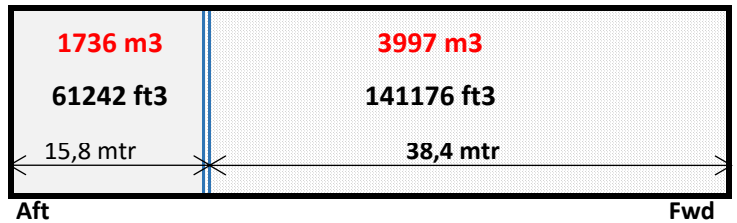

BULKHEAD POSITION 3

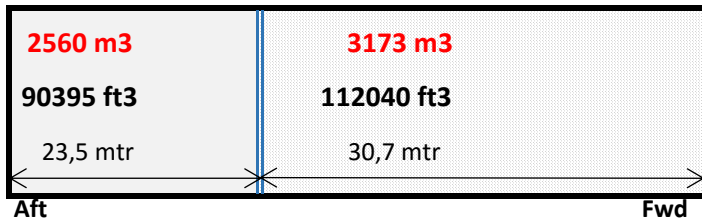

BULKHEAD POSITION 4

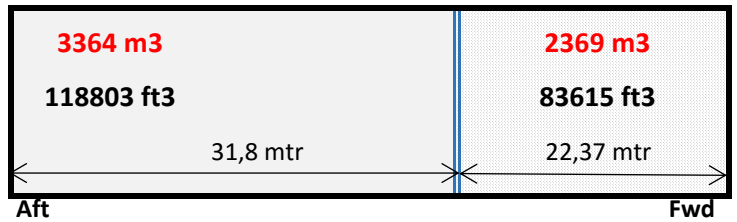

BULKHEAD POSITION 5

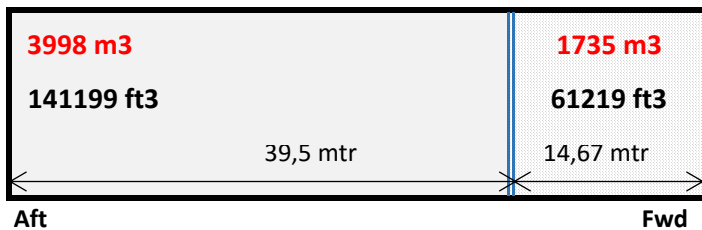

BULKHEAD POSITION 6

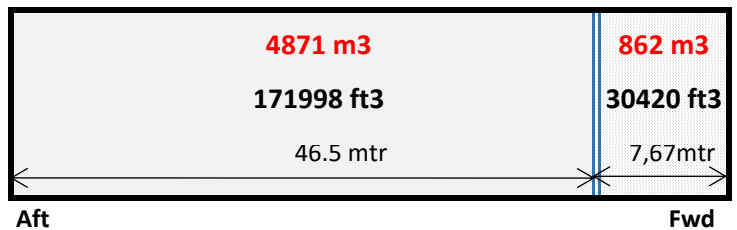

## HATCH COVER

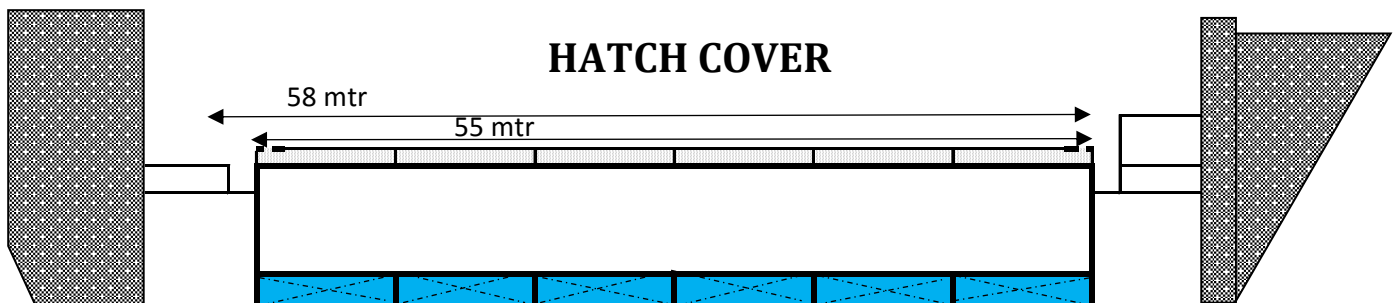

### TWEENDECK POSITION 1

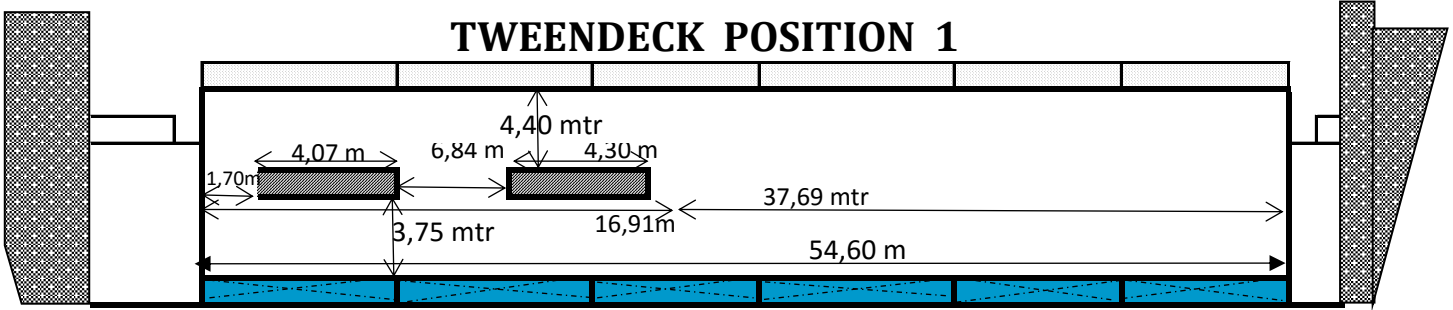

### TWEENDECK POSITION 2

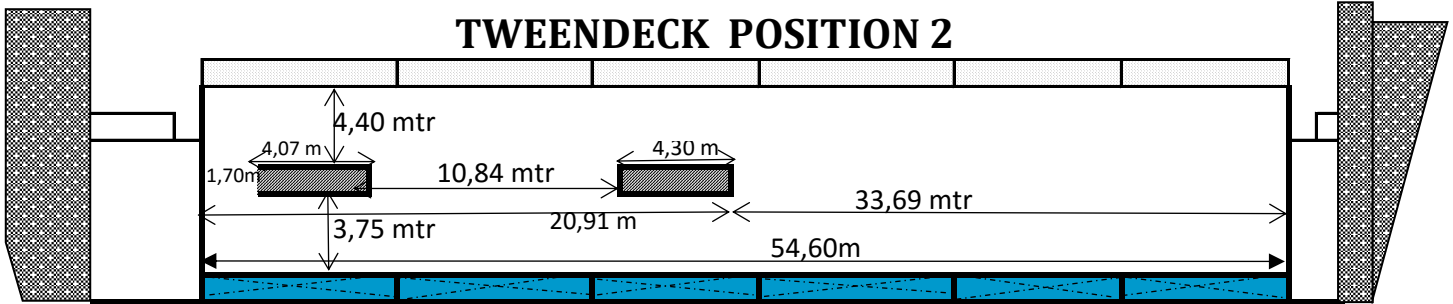

### TWEENDECK POSITION 3

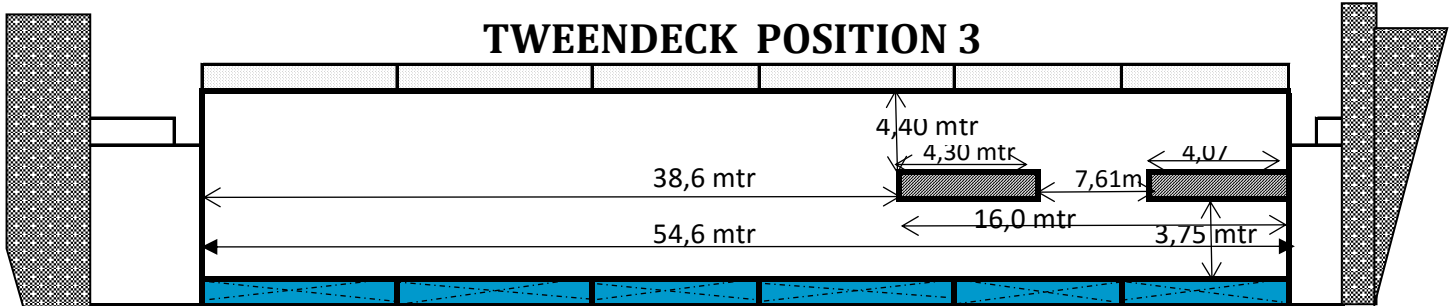

### TWEENDECK POSITION 4

